

## Igo 15

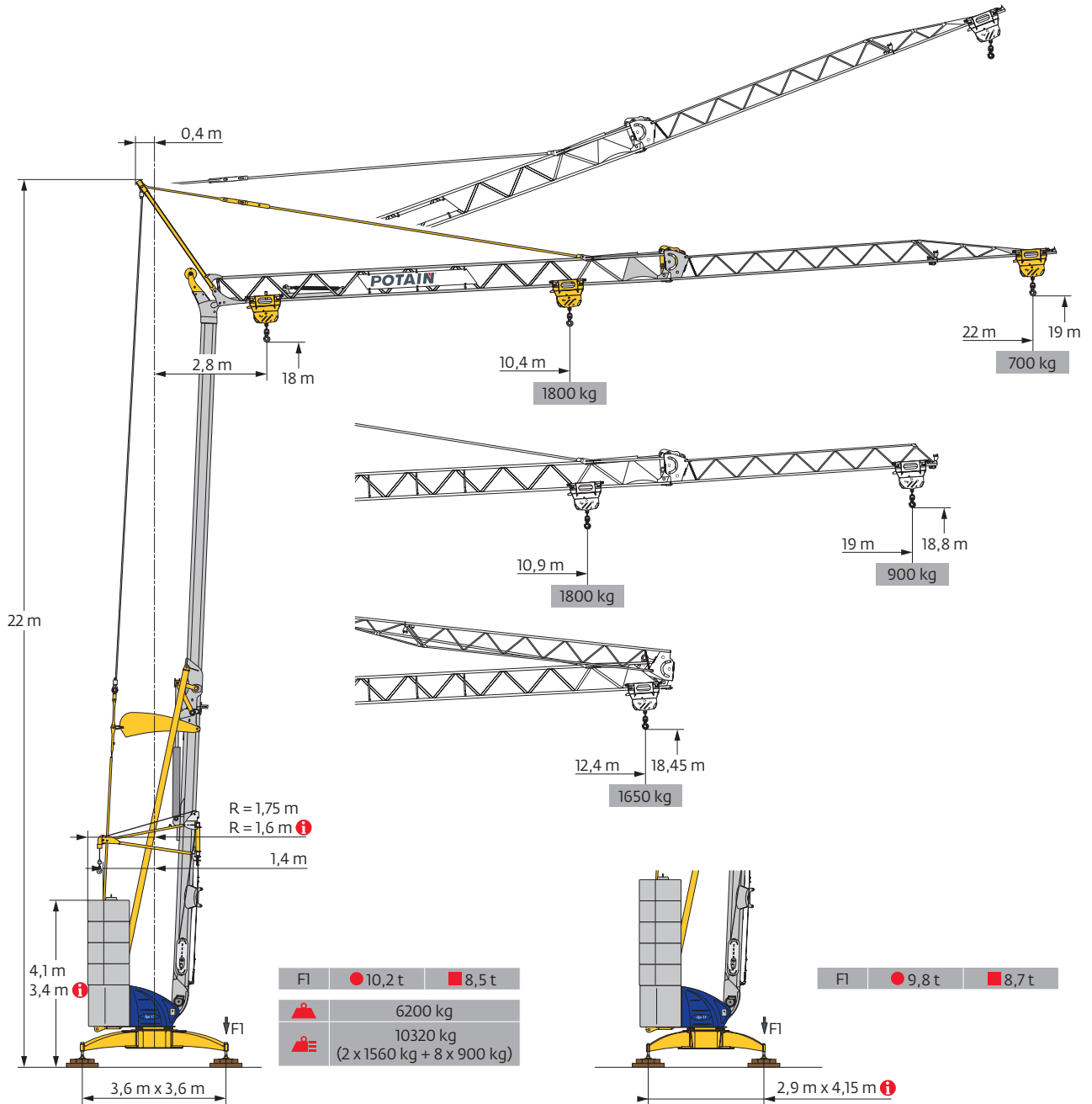

SmartCom

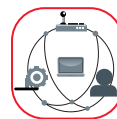

Hydraulic Levelling



Top Zone

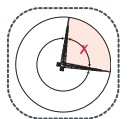

Courbes de charges / Lastkurven / Load curves / Curvas de cargas / Curve di carico  
 Curvas de carga / Кривые нагрузок

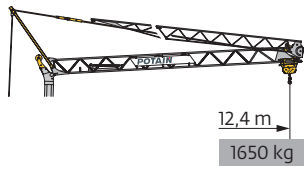

22 m	2,8	▶	11,6	12,4	m
▲▲▲	■		1800	1650	kg
19 m	2,8	▶	11,6	12,4	m
▲▲▲	■		1800	1650	kg



2,8	▶	10,4	11	12	13	14	15	16	17	18	19	20	21	22	m
		1800	1680	1505	1360	1240	1135	1045	970	905	845	790	745	700	kg
2,8	▶	10,9	11	12	13	14	15	16	17	18	19				
		1800	1780	1595	1445	1315	1210	1115	1035	965	900				

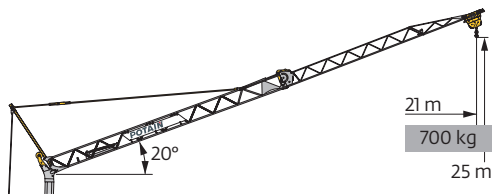



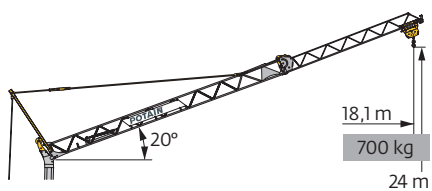

22 m	2,8	▶											21	m
▲▲▲	■												700	kg



19 m	2,8	▶										18,1	m
▲▲▲	■											700	kg

Mécanismes / Triebwerke / Mechanisms / Mecanismos / Meccanismi  
 Mecanismos / Механизмы

230 V - 50 Hz 400 V - 50 Hz 480 V - 60 Hz							ch - PS hp	kW
	<b>8 LVF 9 Optima</b>	230 V $\neq$	m/min	$\updownarrow$ 3,5	$\uparrow$ 5 $\downarrow$ 12,5	$\uparrow$ 11,5 $\downarrow$ 39	3,3	2,4
		20 A <b>1</b>	kg	1800	1800	700		
		230 V $\neq$	m/min	$\updownarrow$ 3,5	$\uparrow$ 6,5 $\downarrow$ 12,5	$\uparrow$ 22 $\downarrow$ 39	5,2	3,8
		32 A <b>2</b>	kg	1800	1800	700		
		400 V	m/min	$\updownarrow$ 3,5	$\updownarrow$ 12,5	$\updownarrow$ 39	7,5	5,5
		480 V <b>3</b>	kg	1800	1800	700		
	<b>1 DVF 4</b>		m/min	14 - 28			1,5	1,1
	<b>RVF 20</b>		tr/min U/min rpm	0 $\rightarrow$ 1			1,5	1,1

 IEC 60204-32	 kVA
230 V (+10% -10%) 50 Hz 400 V (+10% -10%) 50 Hz 480 V (+6% -10%) 60 Hz	230 V 20 A : 4,6 kVA 230 V 32 A : 7,4 kVA 400 V / 480 V : 11 kVA

8 LVF 9 Optima

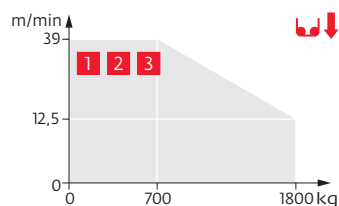
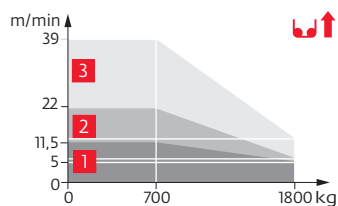

Montage / Montage / Erection / Montaje / Montaggio  
 Montagem / Монтаж

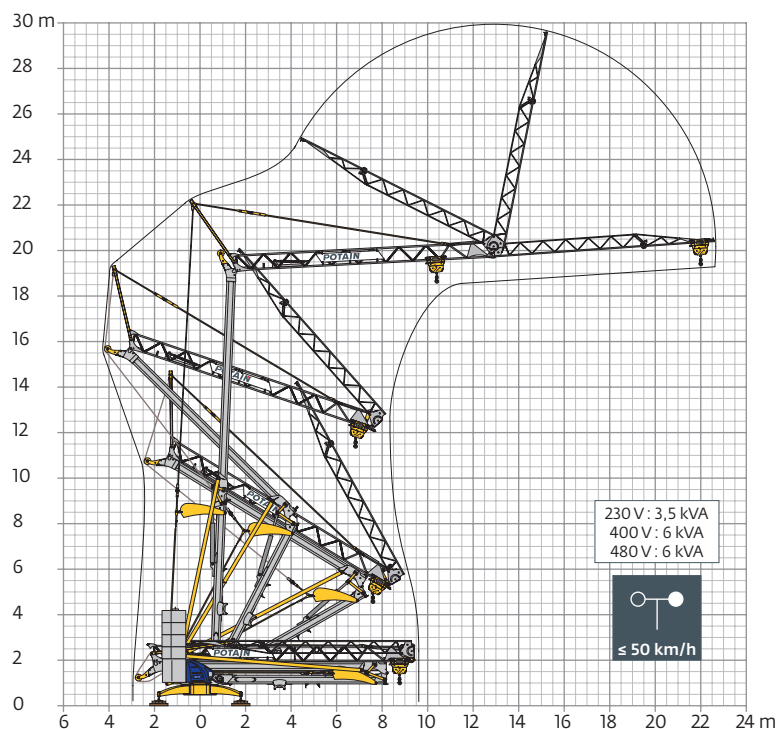

Transport / Transport / Transport / Transporte / Trasporto  
Transporte / Транспортировка

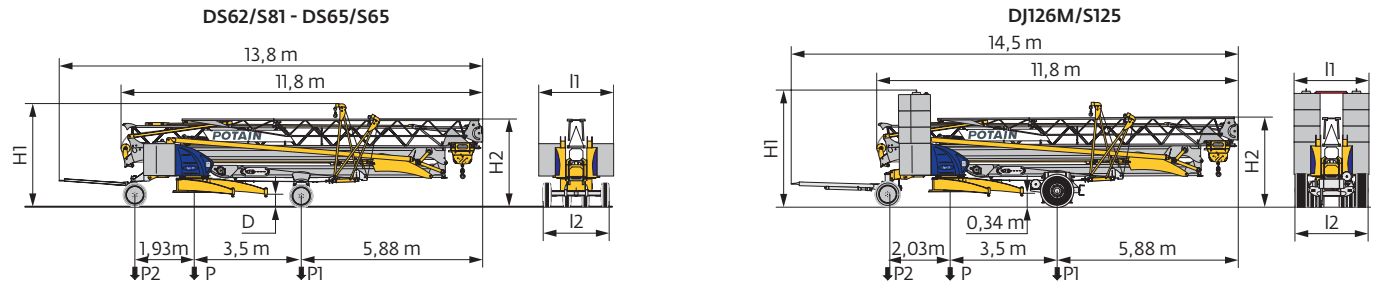

	km/h	D (m)	H1 (m)	H2 (m)	l1 (m)	l2 (m)	P (kg)	P1 (kg)	P2 (kg)
DS62/S81	10	0,33/0,18	3,41/3,26	2,98/2,83	2,48/2,2	2,2	9900	5700	4200
DS65/S65	25	0,33/0,18	3,41/3,26	2,98/2,83	2,48/2,2	2	10210	5820	4390
..... / .....									
	km/h	H1 (m)	H2 (m)	l1 (m)	l2 (m)	P (kg)	P1 (kg)	P2 (kg)	
DJ126M/S125	25	3,76	3	2,48/2,2	2,4	16400	7400	9000	
..... / .....									

Conteneur High Cube 40' / Container High Cube 40' / Conteneur High Cube 40' / Contenedor High Cube 40'  
Container High Cube 40' / Contendor High Cube 40' / 40-футовый контейнер повышенной вместимости High Cube

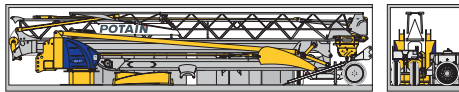

	FR	DE	EN	ES	IT	PT	RU
	Rayon de giration	Schwenk radius	Rear slewing radius	Radio de giro	Raggio di rotazione	Raio de rotação	Задний габарит
	Nous consulter	Auf Anfrage	Consult us	Consultarnos	Consultateci	Consultar-nos	Проконсультируйтесь у нас
	Réactions en service	Reaktionskräfte in Betrieb	Reactions in service	Reacciones en servicio	Reazioni in servizio	Reacções em serviço	Реакция при работе
	Réactions hors service	Reaktionskräfte außer Betrieb	Reactions out of service	Reacciones fuera de servicio	Reazioni fuori servizio	Reacções fora de serviço	Реакция в покое
	Poids à vide, sans lest, sans trains de transport, avec flèche maxi. et hauteur standard.	Gewicht ohne Last, ohne Ballast, ohne Transportachsen, mit max. Auslager und Standardhöhe	Weight without load, without ballast, without transport axes, with max. jib and standard height	Peso en vacío, sin lastre, sin trenes de transporte con flecha y altura estandar	Peso a vuoto, senza zavorra, senza assali di trasporto, con braccio max e altezza standard.	Peso em vazio, sem lastro, sem eixos de transporte com lança máxima e altura standard.	Вес без груза, без балласта, без осей для транспортировки, с максимальным вылетом стрелы и стандартной высотой
	Poids total du lest	Ballast-Gesamtgewicht	Total ballast weight	Peso total del lastre	Peso totale della zavorra	Peso total do lastro	Общий вес балласта
	Équipements standards	Standardausrüstungen	Standard equipment	Equipamiento de serie	Equipaggiamento standard	Equipamento de série	Стандартное оборудование
	Équipements optionnels	Sonderausrüstungen	Options	Equipamiento opcional	Equipaggiamento in opzione	Equipamento opcional	Дополнительное оборудование (опция)
	Levage	Heben	Hoisting	Elevación	Sollevamento	Elevação	Подъем
	Distribution	Katzfahren	Trolleying	Distribución	Distribuzione	Distribuição	Перемещение по стреле
	Orientation	Schwenken	Slewing	Orientación	Rotazione	Rotação	Поворот
	50 Hz Monophasé	50 Hz Einphasige	50 Hz Single phase	50 Hz Monofásica	50 Hz Monofase	50 Hz monofásica	Однофазное напряжение 50Hz
	Puissance requise	Erforderliche Leistung	Required power	Potencia Necesaria	Potenza richiesta	Potência Necessária	Потребляемая мощность
	Transport grue toute lestée.	Krantransport mit voller Ballastierung.	Transport of crane with full ballast.	Transporte grúa completamente lastrada.	Trasporto con gru completamente zavorrata.	Transporte de grua totalmente balastrada.	Перевозка крана с полным балластом
	Hauteurs sous crochet données moufle plaquée	Hakenhöhen werden mit plattiertem Haken angegeben	Hook heights given with plated pulley block	Altura bajo gancho con pasteca bloqueada	Altezza sotto gancio con bozzello in contatto con carrello	Altura ao gancho com o cadernal em contacto com o carrinho	Высота под крюком дана при условии, что крюковая подвеска соприкасается с кареткой
	Document commercial non contractuel	Unverbindliches Vertriebsdokument	This commercial document is not legally binding	Documento comercial no contractual	Documento commerciale non vincolante	Documento comercial não contratual	Этот коммерческий документ не является юридически обязательным
	Pour toute information technique se référer à la notice correspondante	Für technische Informationen, siehe die entsprechenden Anweisungen	For any technical information, please refer to the corresponding instructions	Para cualquier información técnica, ver la noticia correspondiente	Per tutte le informazioni tecniche fare riferimento al catalogo istruzioni	Para qualquer informação técnica complementar consultar as respectivas instruções	Для получения технической информации, см. соответствующие инструкции

